

Assembly Instructions

Important Safety Instructions

- Please read all instructions carefully before assembling this desk.
- For your safety, assembly by two or more adults is strongly recommended.
- Keep these instructions for future use.
- Use only vendor supplied hardware to assemble this item. Using unauthorized hardware could jeopardize the structural integrity of the item.

Pre-Assembly

- Remove all parts and hardware from the box. Place them on a carpeted or scratch-free work surface, as this will avoid damaging parts during assembly. The shipping box provides an ideal work surface.
- To avoid accidentally discarding small parts or hardware, do not dispose any packaging or contents of the shipping carton until assembly is complete.
- Use the parts and hardware list on the right to identify and separate all of the pieces included.
- The illustrations provided allow for easier assembly when used in conjunction with the assembly instructions.
- The use of power tools to aid in assembly is not recommended. Power tools can damage hardware and split wood.

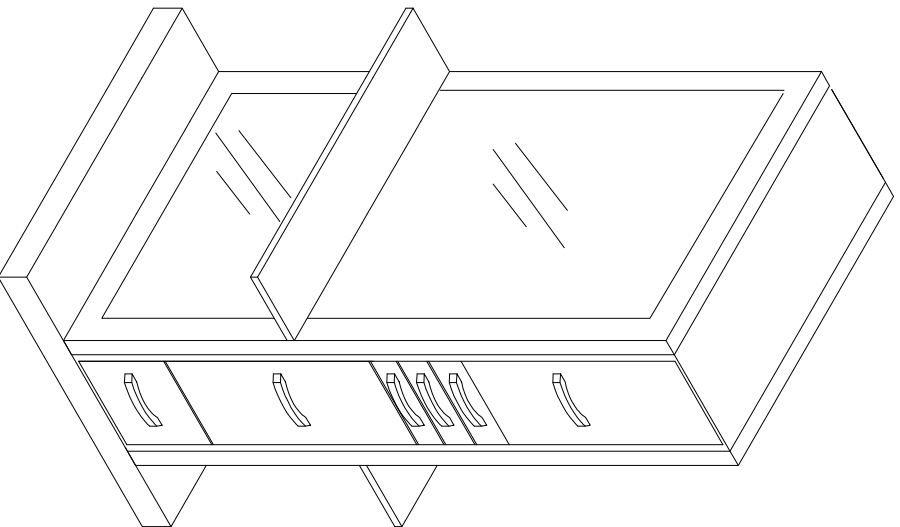





Kamino Double Sided
Styling Station

Model #3364



Care Instructions

- Dust often using a clean, soft, dry and lint-free cloth.
- Blot spills immediately and wipe with a clean, damp cloth.
- We do not recommend the use of chemical cleansers, abrasives, or furniture polish on our lacquered finish.
- Hardware may loosen overtime. Periodically check to make sure all connections are tight. Re-tighten if necessary.

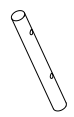
PARTS LIST**

Part	Qty.	Description	Sketch	
A	4	Short Allen bolts (M8x20) or (M8x25)		
B	4	Short Allen bolts (M8x22) or (M8x18)		
C	32	Allen bolts (M8x30)		
D	36	Washer Set		
E	6	Appliance rings		
			J 4 Tube	

**Open all drawers and boxes to check for parts before beginning assembly.

Tools required:
 Allen wrench (Included)  
 Phillips-head screwdriver (Not included)

Components (Label - Description)

- 1 - Base
- 2 - Bottom cabinet section
- 3 - Top Cabinet Section
- 4 - Mirror Panel (2x)

1 - Mounting bottom cabinet section

- 1) Remove all the drawers from the bottom cabinet section by pressing the black release tabs in the glides (one up, one down) and pulling. Remove the drawers slowly and carefully so as not to damage the glides.
- 2) Set the bottom cabinet section on top of the base, aligning the 4 holes in each.
- 3) Secure the bottom cabinet section to the base using 4 short Allen bolts (C) and washer sets (D).

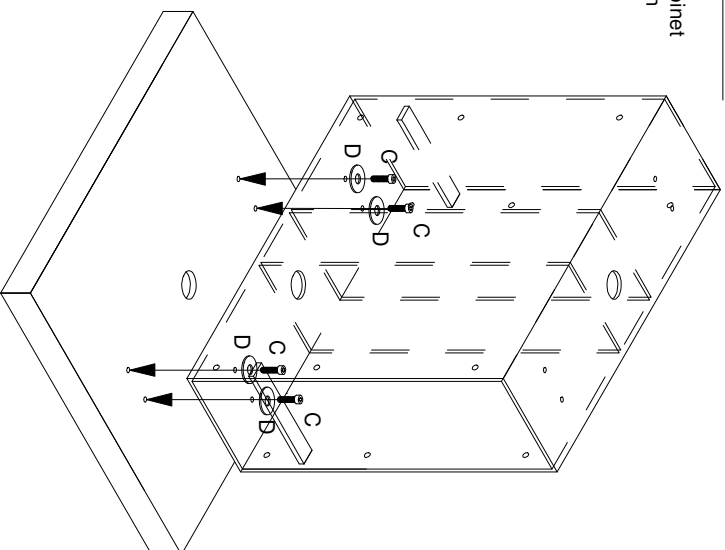

2 - Mounting the top cabinet section

- 1) Remove all the drawers from the top cabinet section by pressing the black release tabs in the glides (one up, one down) and pulling gently. Lay drawers out in proper order for replacement.
- 2) Set the top cabinet section on top of the bottom cabinet section, aligning the 4 holes in each.
- 3) Secure the top section by screwing the 4 remaining short Allen bolts (A+D+B) upward through both cabinet sections into the anchors in the top section.

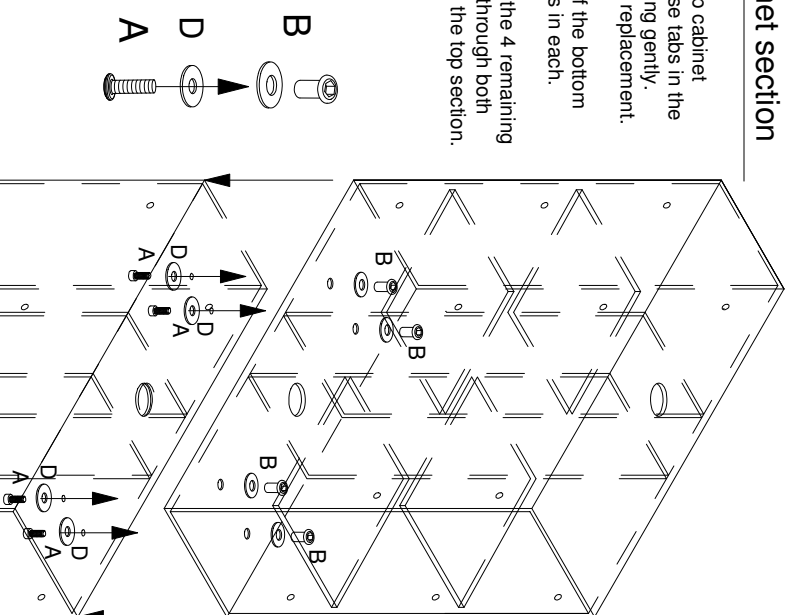

3 - Mounting the mirror panels

- 1) Rotate the mirror panel such that the holes in the back of the panel are aligned with the holes in the front faces of the bottom and top cabinet sections.
- 2) Anchor the mirror panel to the cabinets using 12 long Allen bolts (C) and washer sets (D).
- 3) Repeat steps 1 and 2 for the back mirror panel, using the same configuration of bolts and washers.

Place the flat washers over the bolts first, and the lock washers second.

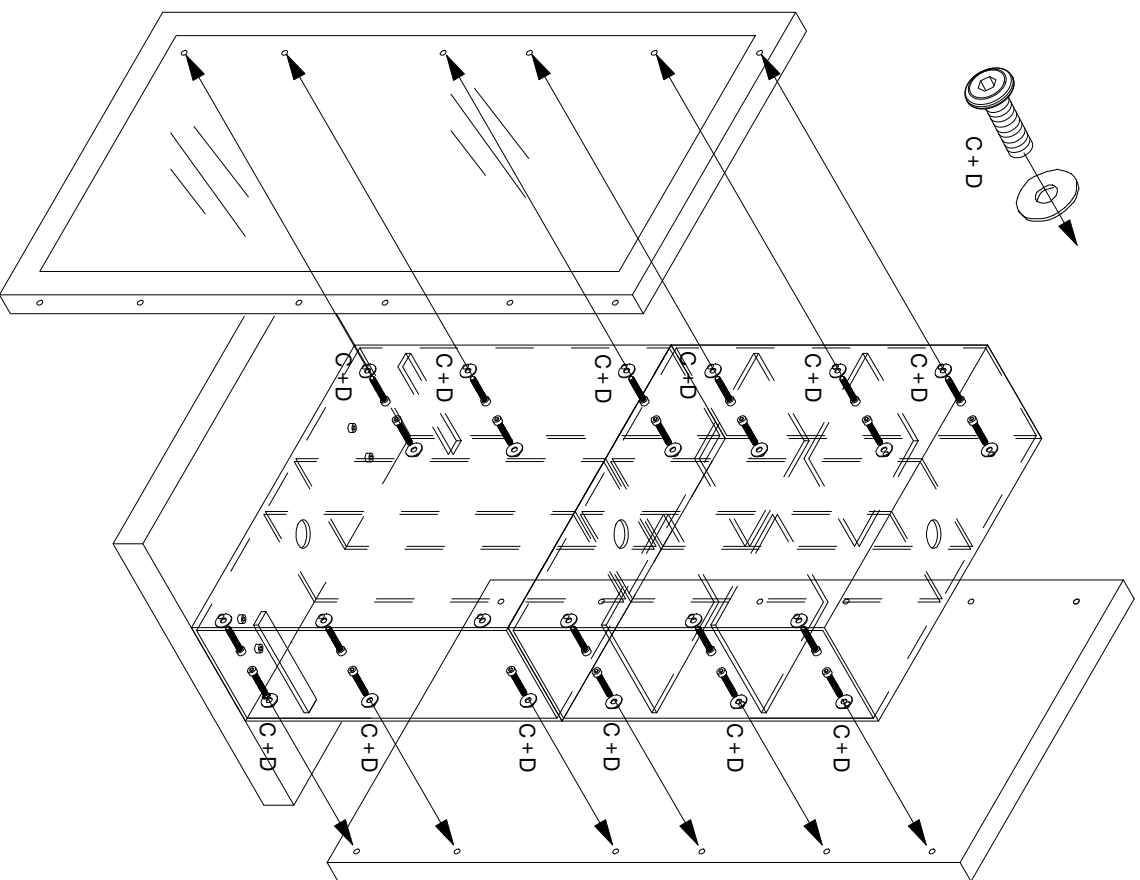

4 - Finishing Touches

- 1) For shipping, the drawer handles are attached to the insides of the drawer faces. Using a Phillips-head screwdriver, remove the 2 screws in each and reattach the handles on the front of the drawers.
- 2) Drop the metal appliance rings (E) into the holes in the appliance drawers.
- 3) Slide the drawers back into their respective glides.

